

Join the Dots

A

ARROW

The arrow that was shot at Lord Krishna by Bhishma at the battle of Kurukshetra, was like a kiss of a flower from his devotee-warrior.

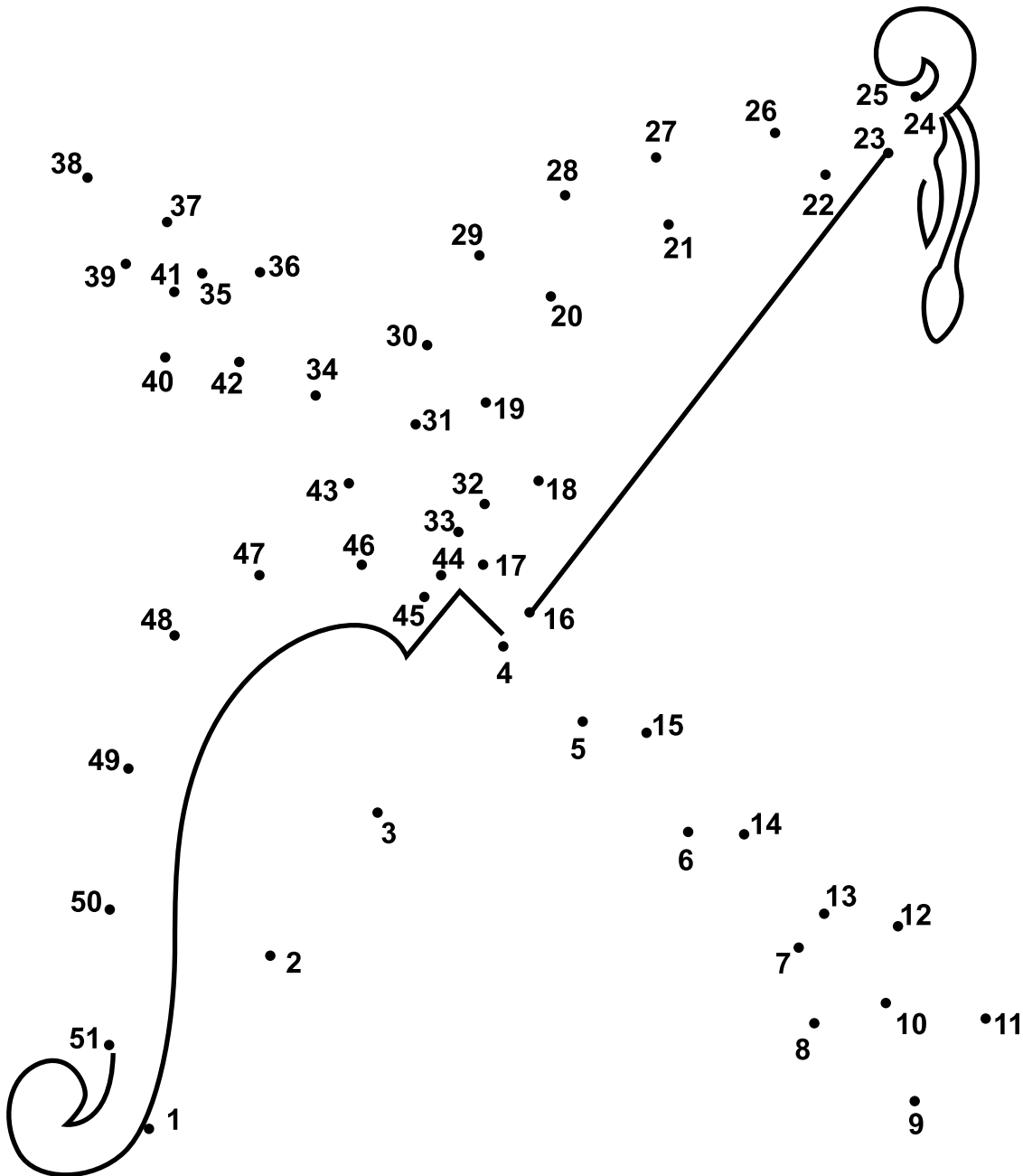

Join the Dots

B

BELL

The temple bell is the symbol of awakening and purifying. Bell is used as one of the aarti paraphernalia for the Lord. We ring the bell while offering the bhoga to the Lord.

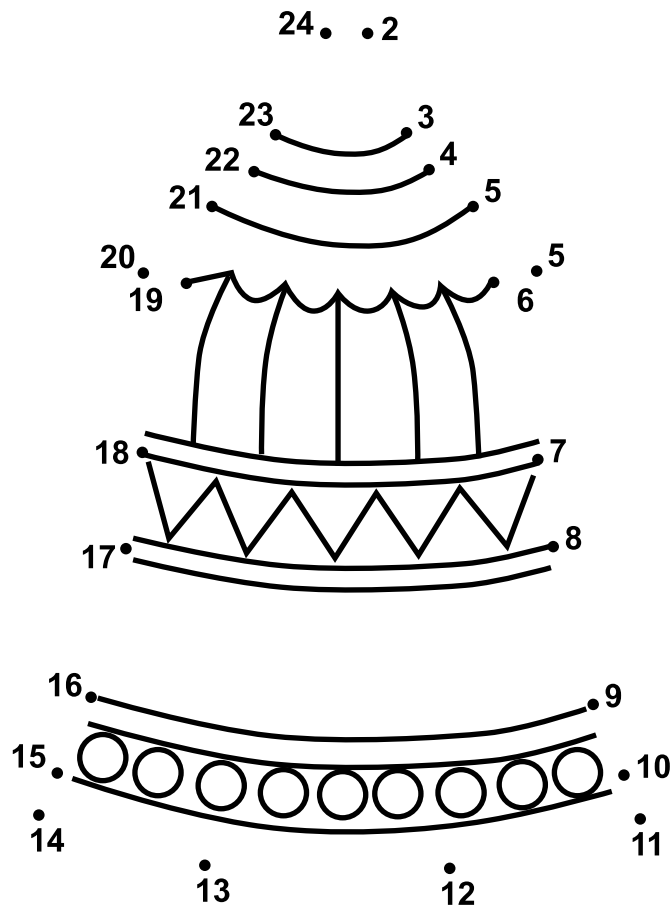
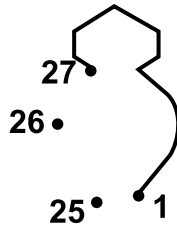

Join the Dots

C CONCH

The Conch that was blown by Lord Krishna on the battle of Mahabharata is known as 'Panchajanya'. Conch is used as one of the aarti paraphernalia for the Lord.



Join the Dots

D

DRUM (Mridanga)

The drum that is played in the Sankirtana movement of Lord Chaitanya is known as 'Mridanga'

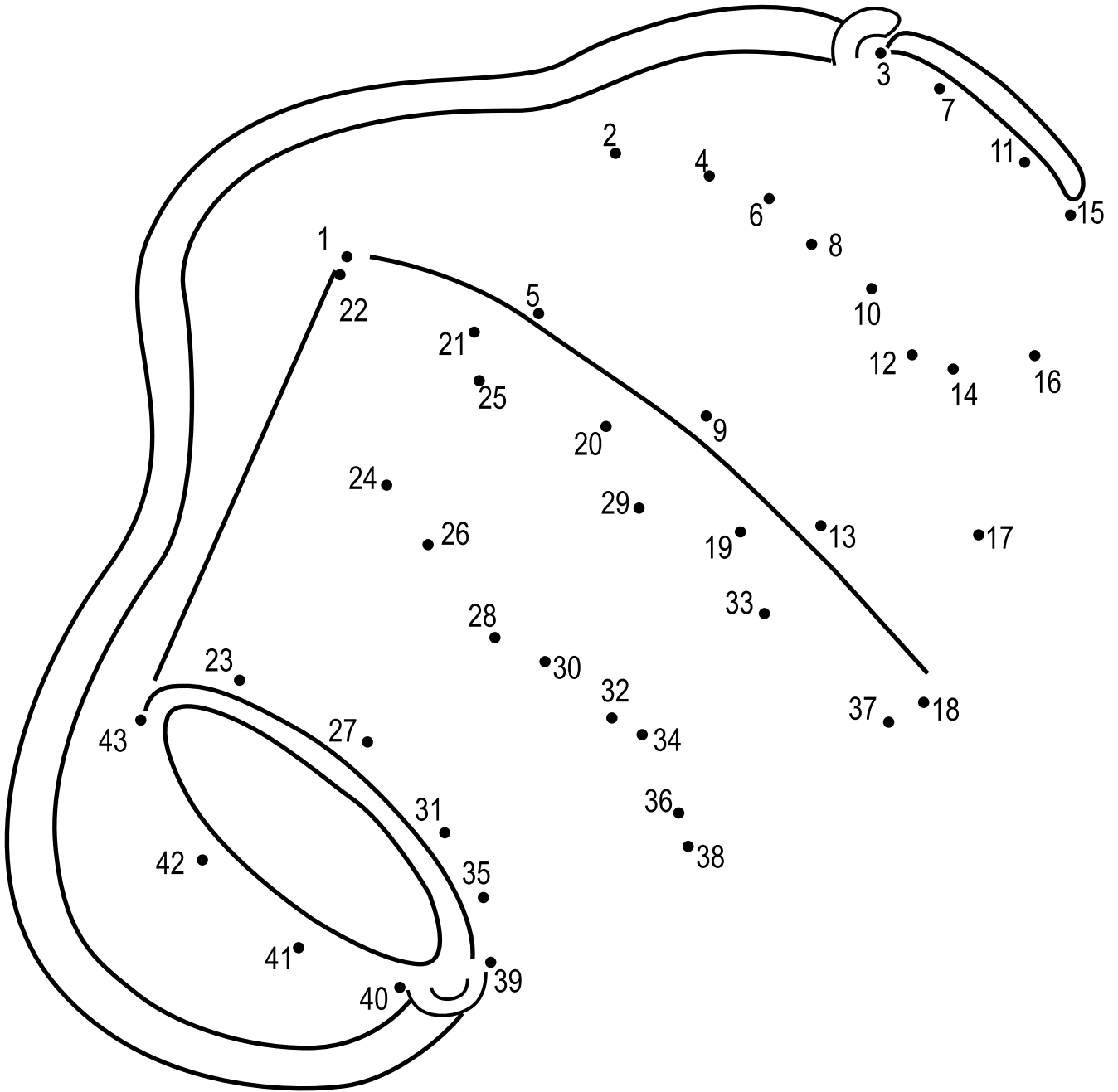

Join the Dots

E

Ekadasi

Ekadasi is the eleventh day from the full and new moon day.

Abstinence from grains and beans is prescribed. We should chant & hear the glories of the Lord throughout the day.



Join the Dots

F

FEATHER

Krishna looks very beautiful with peacock feather on his forehead. Fan made up of peacock feathers is used as one of the aarti paraphernalia for the Lord.

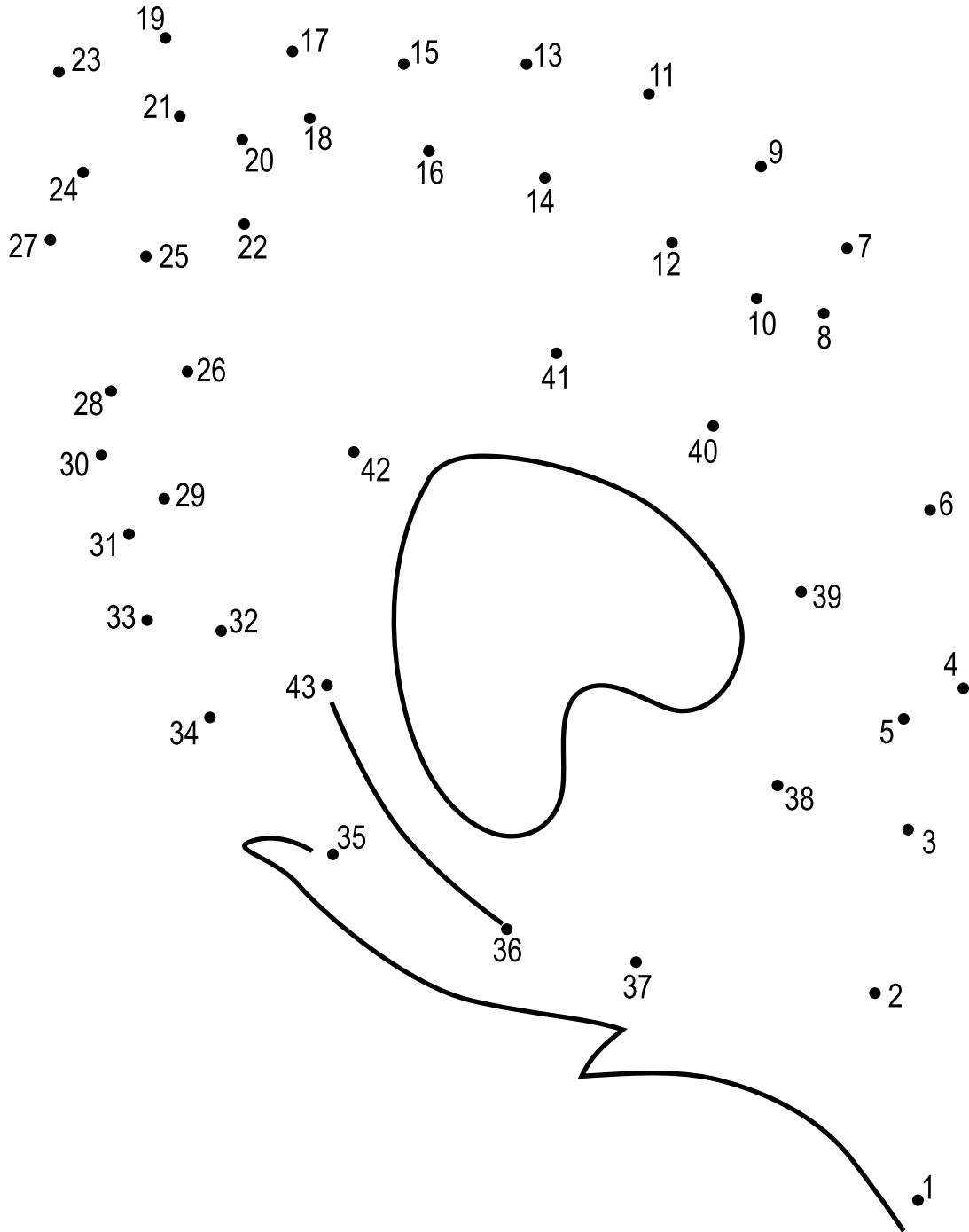

Join the Dots

GOPIS

G

Gopis are Krishna's cowherd girl friends. They would make butter so that Krishna would come & steal from them. They are the top most devotees who would take all types of risk to serve Krishna.



Join the Dots

H

HANUMAN

The great monkey servitor of Lord Ramachandra. He was the first one to go & meet mother Sita at lanka. He was very enthusiastic to do extra service for his master.

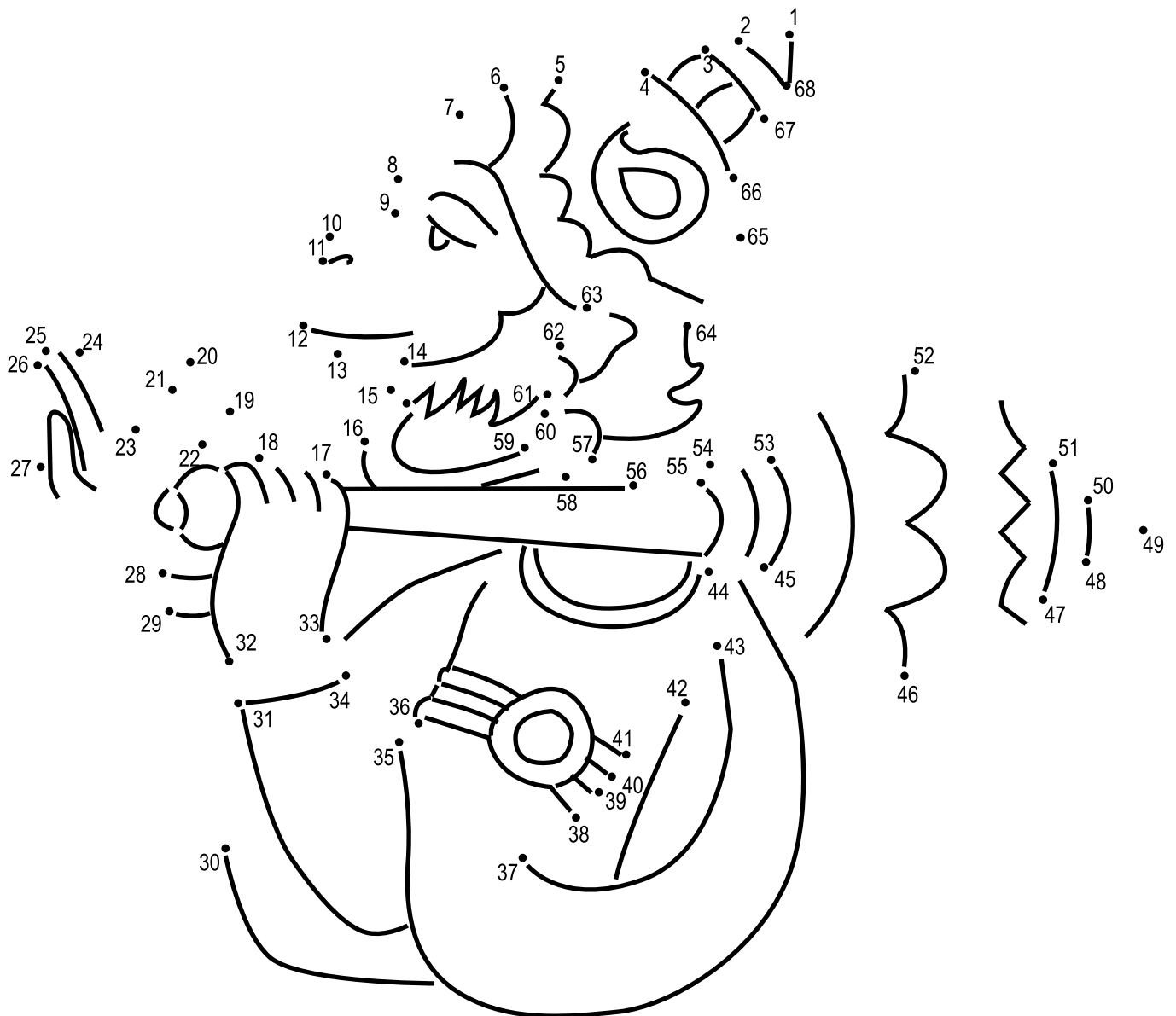

Join the Dots

I

INDRA

the chief of the administrative demigods,
king of the heavenly planets and presiding
deity of rain.



Join the Dots

J

JATAYU

Jatayu tried to save mother Sita by fighting with demon Ravana, though he was very old. He gave the news to Lord Rama that mother Sita was kidnapped by Ravana.



Join the Dots

K

KRISHNA

is the Supreme Personality of Godhead. He used to play with his cowherd friends in the forest of vrindavan & govardhan hill. He would steal butter of the gopis & please them by his charming pastimes.



Join the Dots

L

LOTUS

O Lord, you are always decorated with garlands of lotus flowers, whose glance is as cool as the lotus and whose feet are engraved with lotuses.

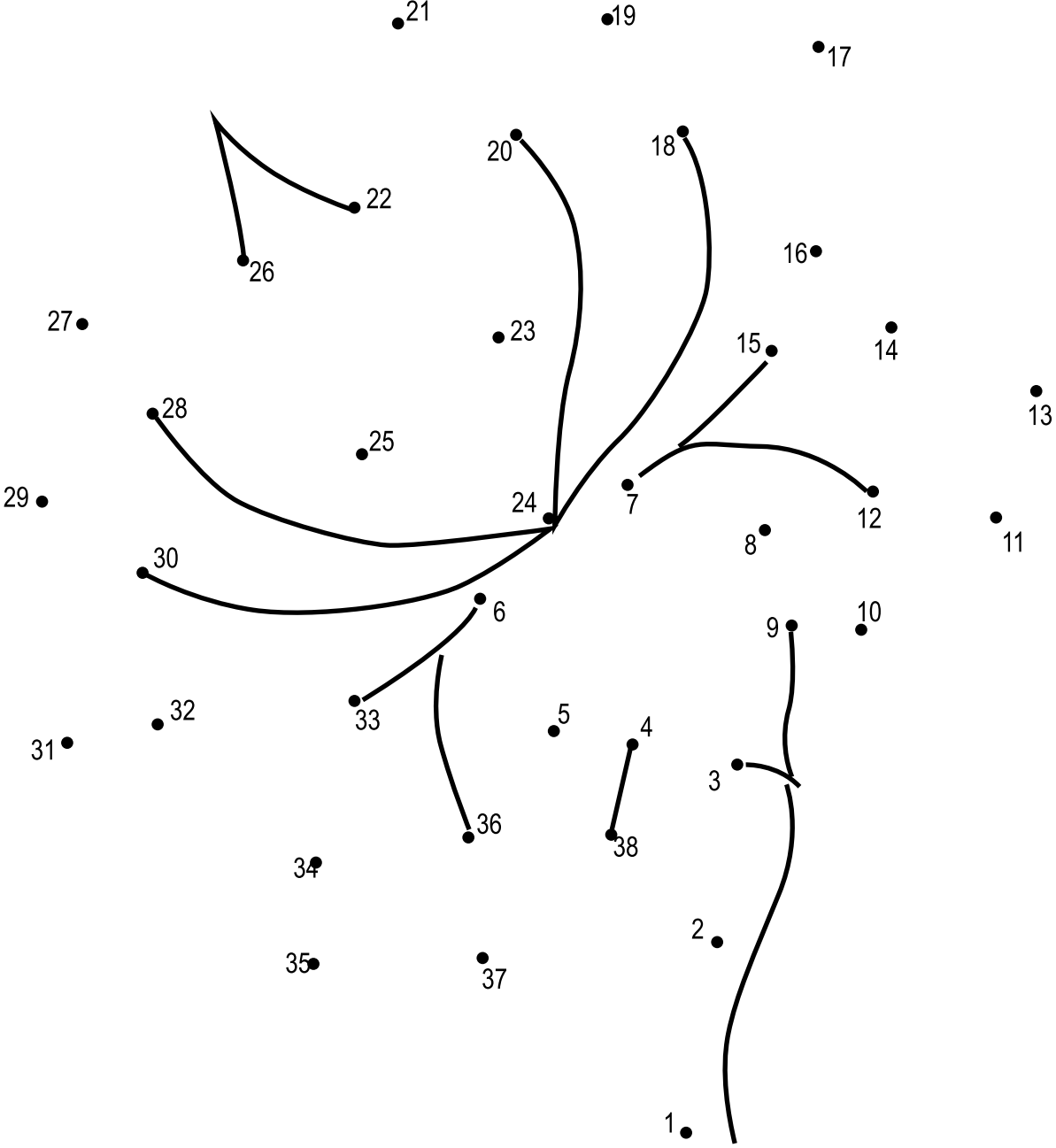

Join the Dots

M

MOUNTAIN

Known as 'Mandara', was once used as a churning-rod by the gods and demons to get the Nectar. They used a huge snake (Vasuki) as the churning-rope around the mountain

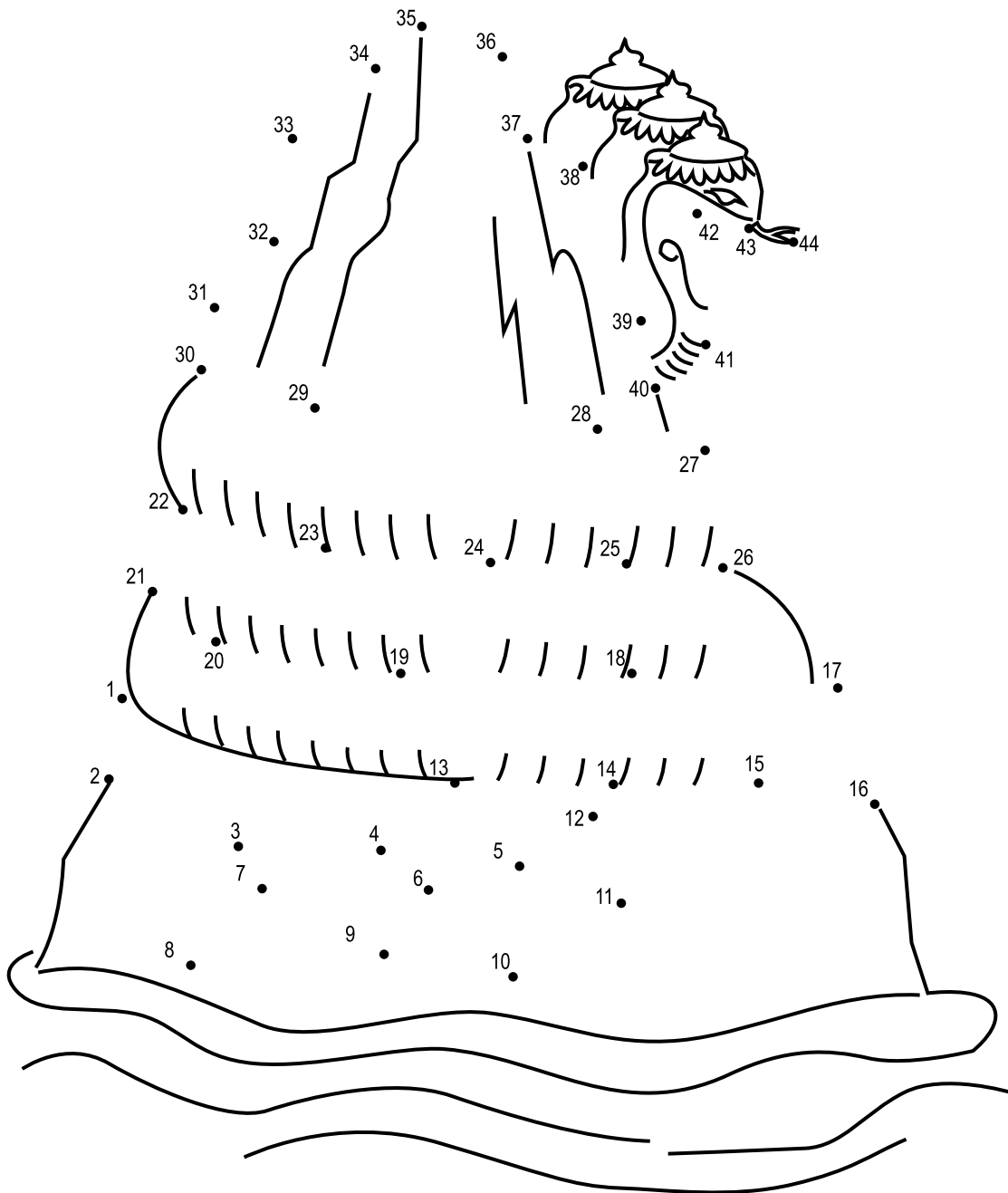

Join the Dots

N

LORD NARSIMHADEV

The incarnation of the Lord as a half man, half lion. He killed the demon Hiranyakasipu to save his devotee Prahlada.



Join the Dots

O

OX

Ox is regarded as our father because it tills the lands from which the farmer produces our food grains on which our lives subsist.

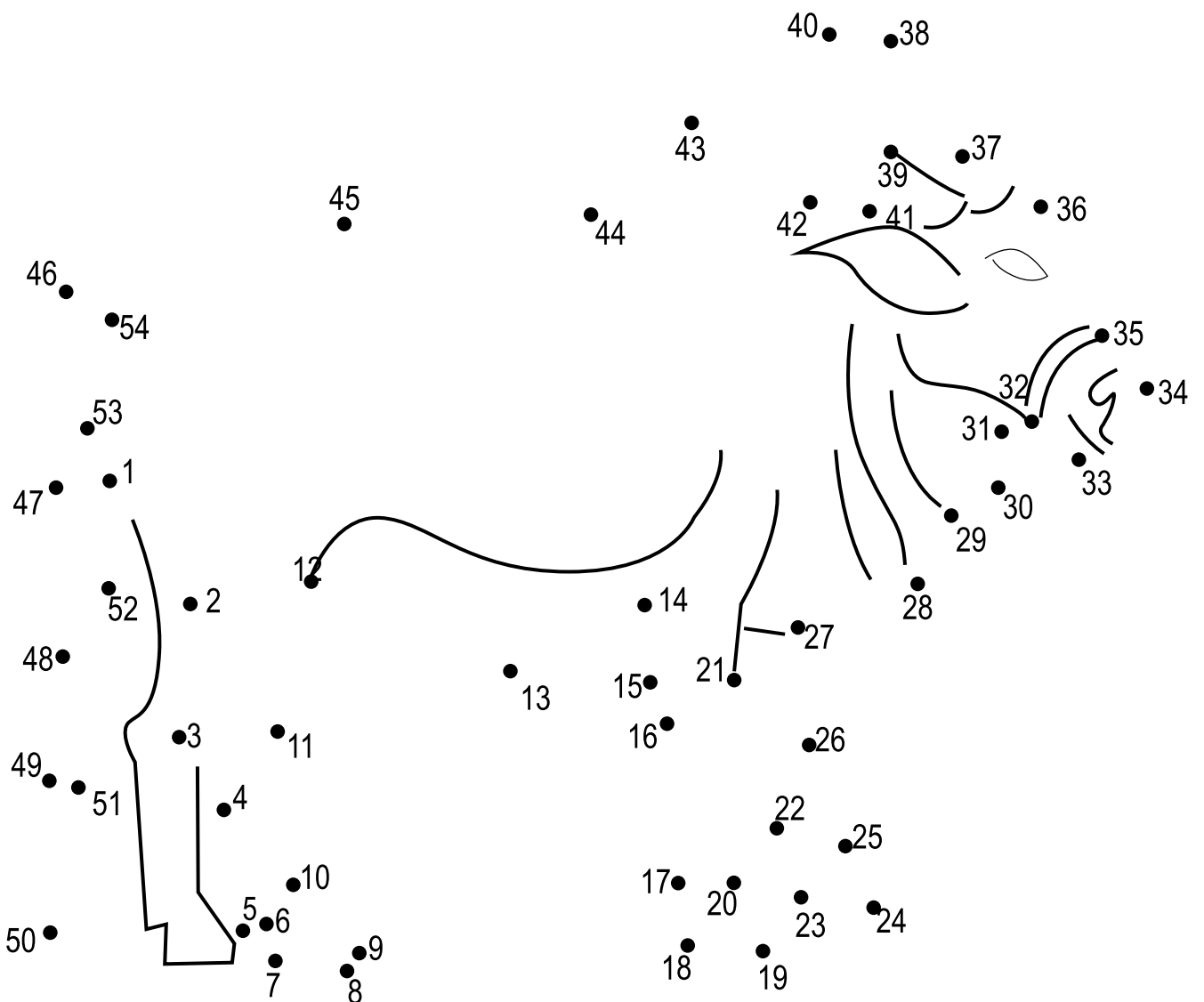

Join the Dots

P

PANCH-AARTI

This is used as one of the aarti paraphernalia for the Lord.

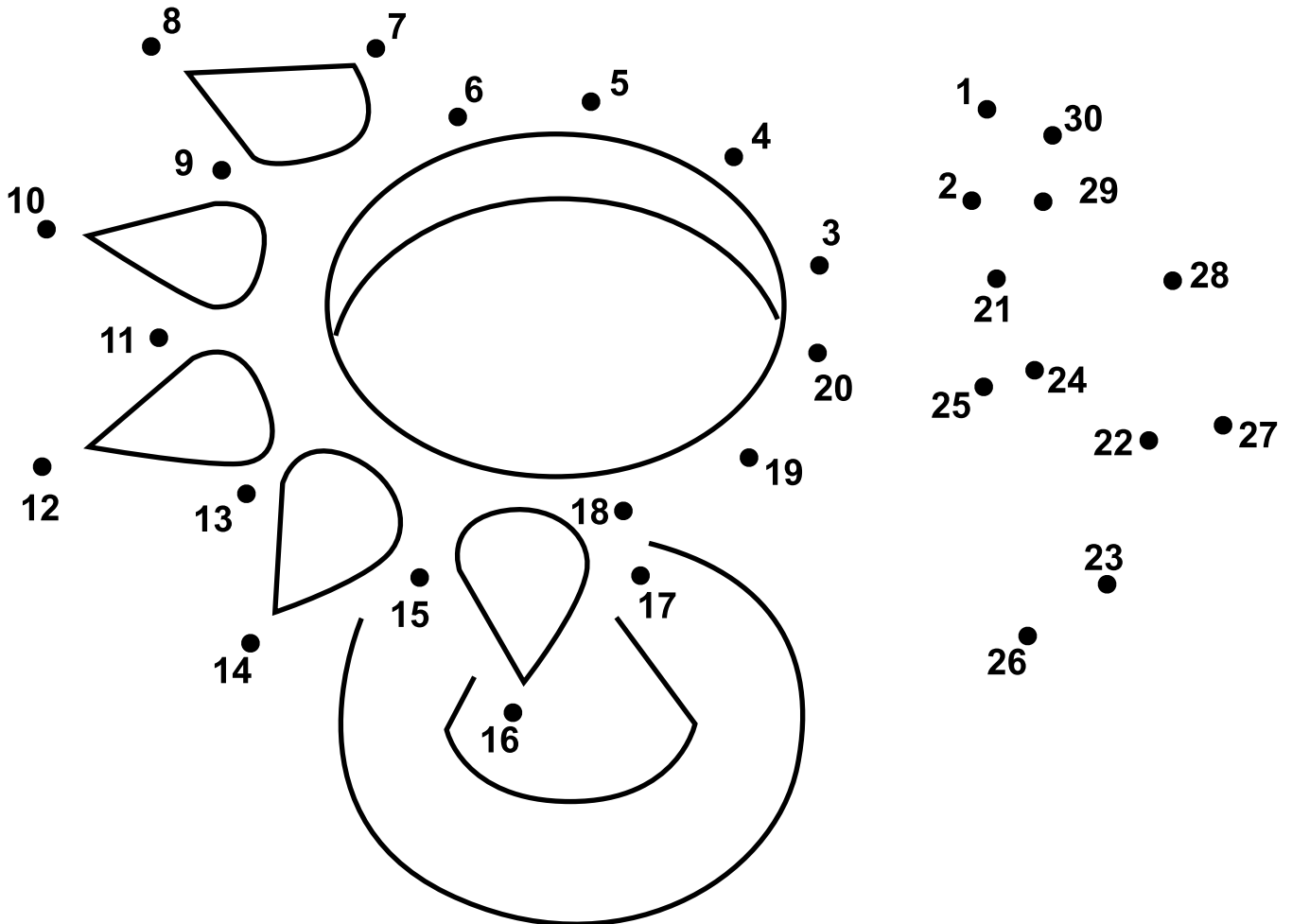

Join the Dots

Q

QUEEN KUNTI

Queen Kunti was the mother of Pandavas & aunt of Lord Krishna. The prayers of queen Kunti are very famous.

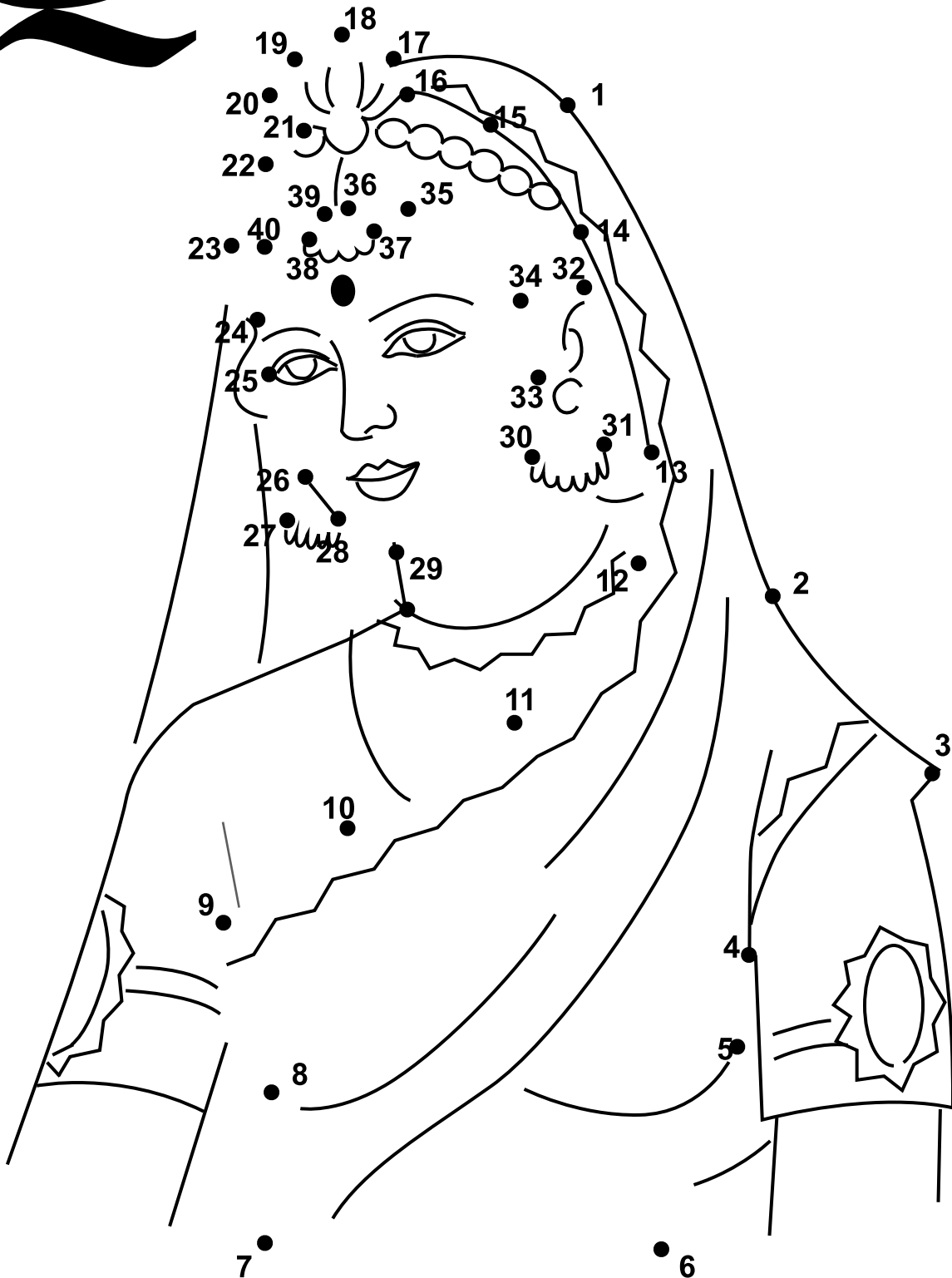

Join the Dots

R

RATHAM

Ratham is used to carry the Deities in a procession during festivals, accompanied by devotees, musical instruments and Kirtan chanters.

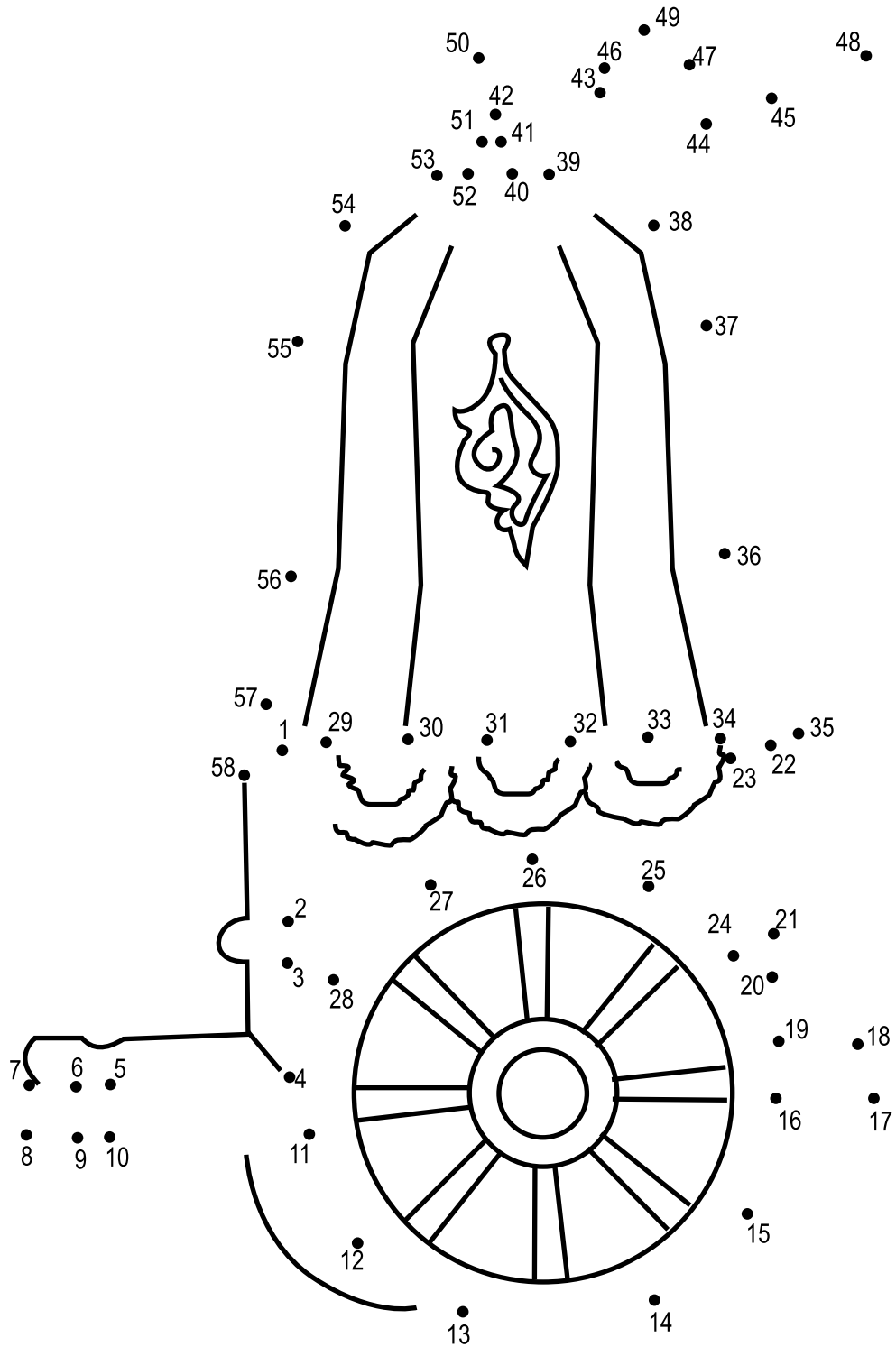

Join the Dots

S

SWAN

It is an elegant bird, dwells only in nice lakes, pure in quality, can be able to discriminate milk from water while drinking. Sainly persons are often compared with Swans.



Join the Dots

T TRINAVARTA DEMON

Trinavarta, a servant of Kamsa appeared like a whirlwind in vrindavan. He carried Krishna on his shoulders and went high up in the sky. Krishna became heavy like a mountain and pulled him down. Krishna caught hold of the demon's neck tightly & killed him.



Join the Dots

U

UMBRELLA

Lord Vamanadeva is always holding in His hands the danda, the umbrella and a waterpot.

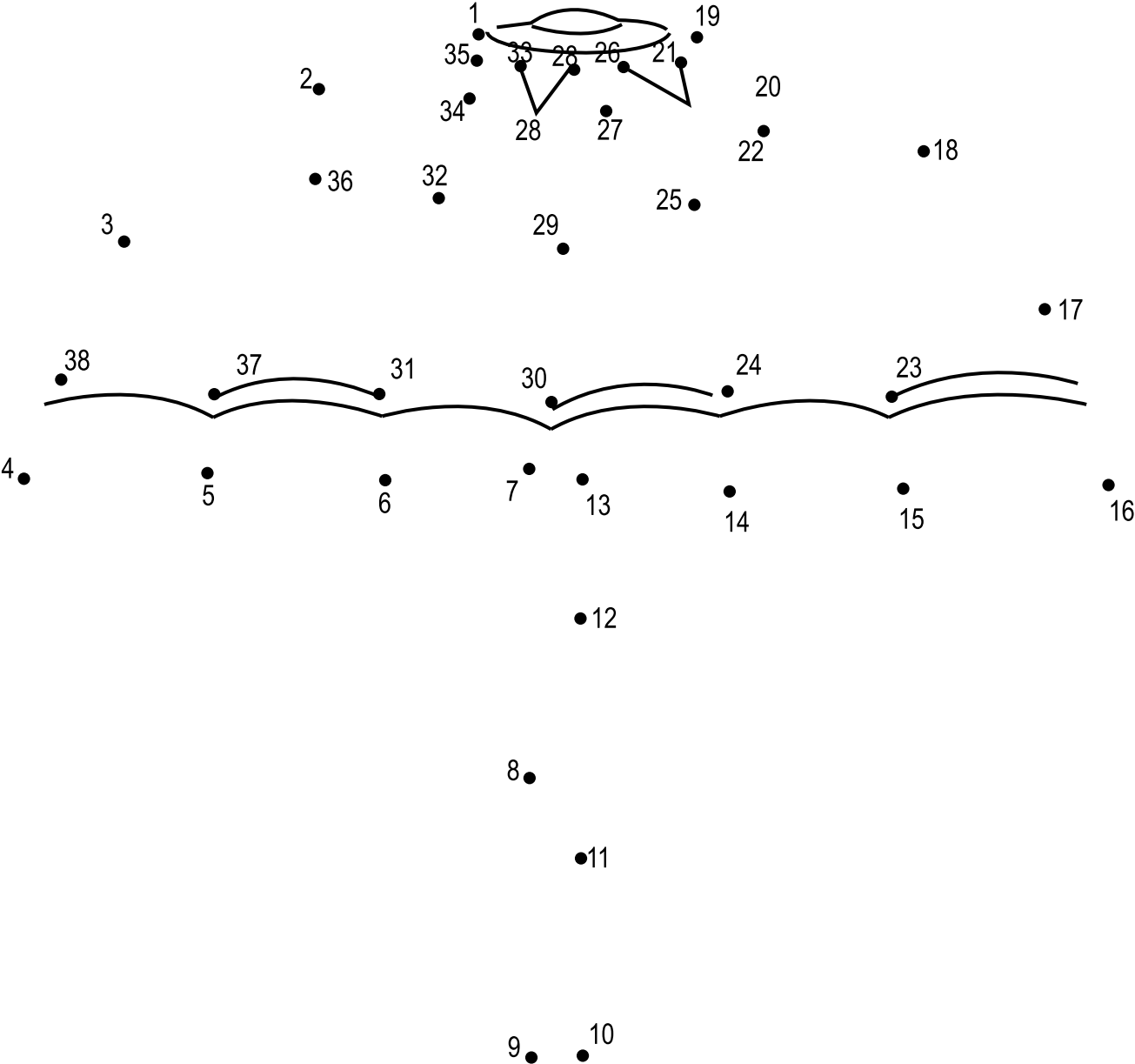

Join the Dots

Y

YAMRAJ

The Demigod who punishes the sinful after death. He is one of the mahajans.

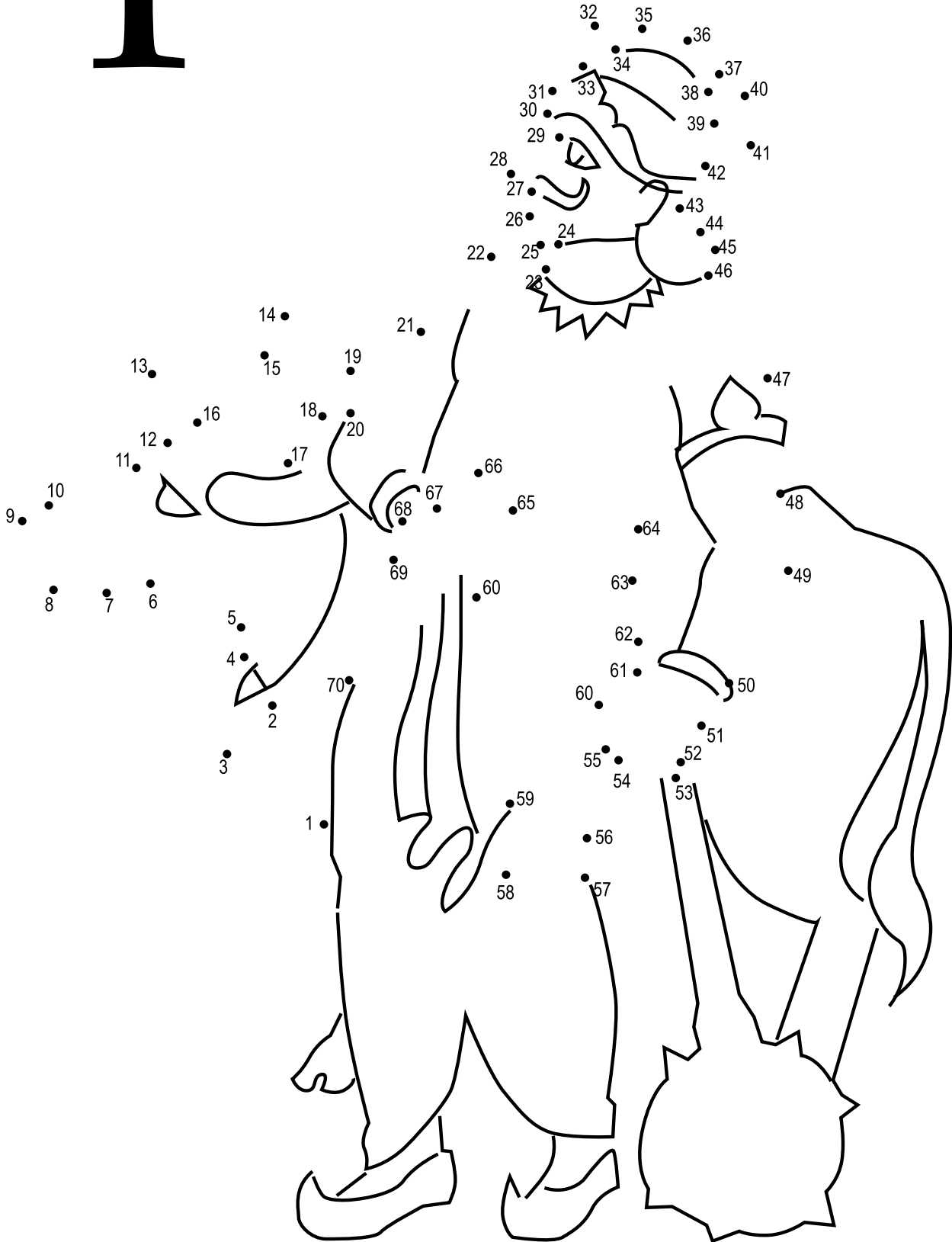

Join the Dots

Z

ZERO

Zero was invented by Aryabhata in India.
Zero does not have any value unless we put 1 (Krishna)
in front of it, then the value of zero increases.

